

ARMADI E COLONNE

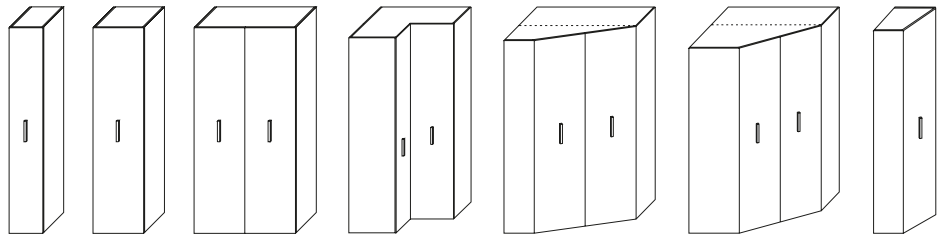

TIPOLOGIE COLONNE

L 36 cm x P 35-62,3 cm x H 220-256,1 cm

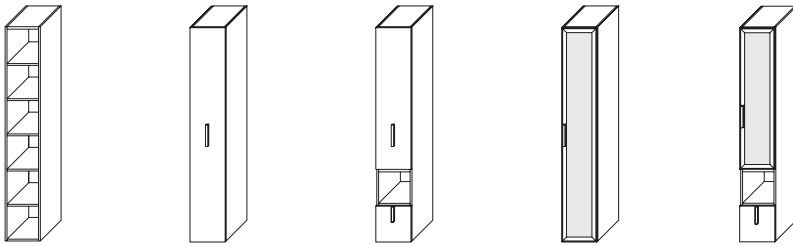

L 54 cm x P 35-62,3 cm x H 220-256,1 cm

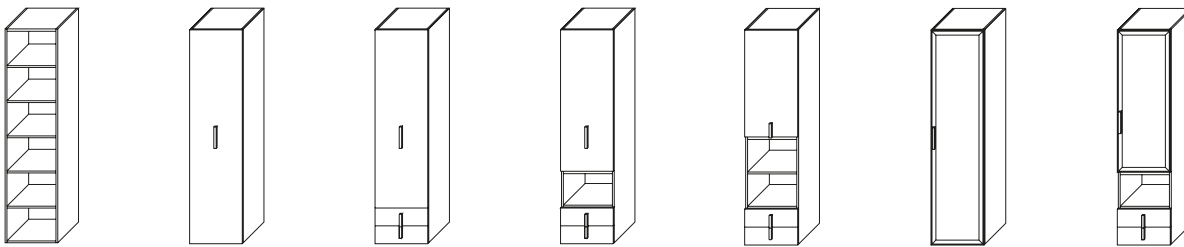

L 108 cm x P 35-62,3 cm x H 220-256,1 cm

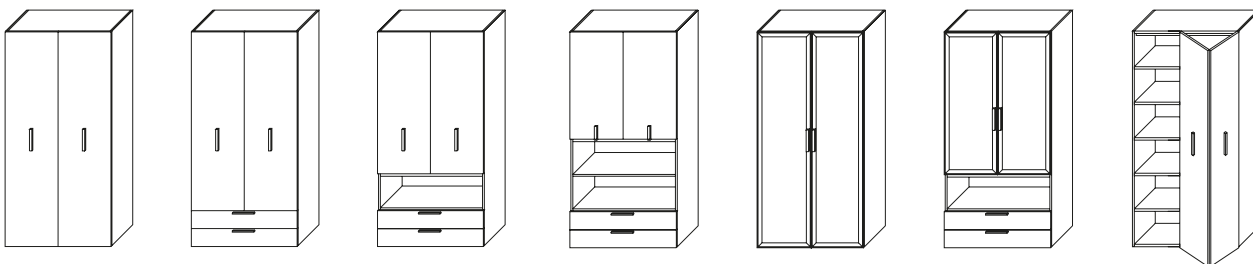

FINITURE DI SERIE

STRUTTURA - Melaminico bianco, rovere sabbia, rovere moro, perla, tortora. Laccato nelle varianti Cleicoloursystem.

FIANCHI ESTERNI - Laccato nelle varianti Cleicoloursystem. Essenze: noce dogato e rovere termotrattato.

ANTE IN LEGNO - Melaminico bianco, rovere sabbia, rovere moro, perla, tortora. Laccato nelle varianti Cleicoloursystem. Dialux bianco. Laccato multicolour 2-3 moduli. Essenze: noce dogato e rovere termotrattato.

ANTE IN VETRO - Acidato, Specchio fumè, laccato, specchio satinato (argento), trasparente, laccato bianco riflettente.

ANTE DIALUX FUGATO - Dialux bianco con fughe laccate.

ANTE A GOLA VERTICALE - Melaminico bianco, rovere sabbia, rovere moro, perla, tortora. Laccato nelle varianti Cleicoloursystem. Dialux bianco. Maniglia a gola verticale laccata in tutte le varianti Cleicoloursystem.

Ogni colonna in profondità 62,3 include:

- in H 220 cm: 1 ripiano sp. 4 cm e 1 tubo appendiabiti
- in H 256,1 cm: 1 ripiano sp. 4 cm e 2 tubi appendiabiti.

ATTREZZATURE INTERNE COLONNE / ANGOLARE / CABINE



Tubo appendiabito



Tubo appendiabito luminoso



Luce LED sottoripiano

CASSETTIERE INTERNE

Guide metalliche con sistema frenante, scocca in multistrato di betulla.

Disponibili con maniglia applicata.

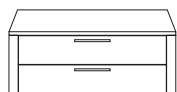

2 cassetti



4 cassetti



6 cassetti

ATTREZZATURE INTERNE SOLO PER COLONNE

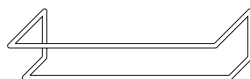

Portascarpe estensibile
L da 46 a 70 x P 19,5 x H 8,8 cm
L da 80 a 110 x P 19,5 x H 8,8 cm

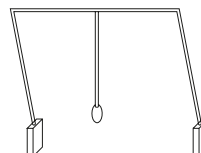

Servetto
L da 77 a 120 cm

FINITURE DI SERIE

Melaminico bianco, rovere sabbia, perla, tortora.

ANTE

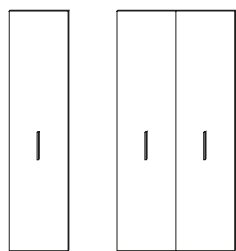

Ante in legno, apertura a battente o a pacchetto.

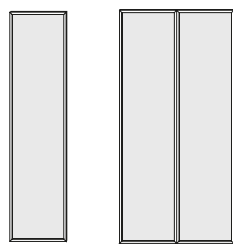

Ante in vetro con telaio in alluminio, apertura a battente o a pacchetto.

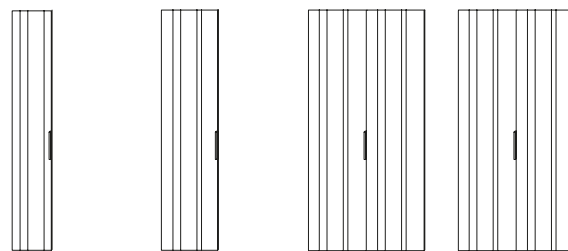

Ante Dialux fugato, maniglia filo anta. Per ante in H cm 220 e cm 256,1.

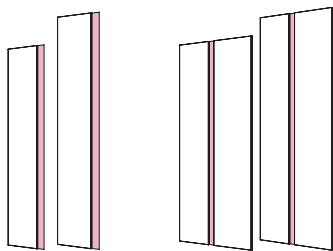

Anta gola verticale, da 30 a 80 mm, apertura battente. Per ante in H cm 220 e cm 256,1.

FINITURE DI SERIE

Alluminio anodizzato, laccato in tutte le varianti Cleicoloursystem.

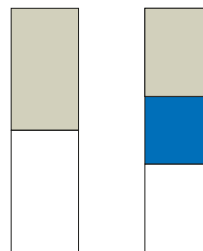

MULTICOLOUR

Combinazioni come da campionario Cleicoloursystem. Maniglia standard applicata. Per ante in H cm 220 e cm 256,1.

**BOISERIE**

Pannelli verticali modulari personalizzabili con mensole e accessori, integrabili con i sistemi trasformabili.

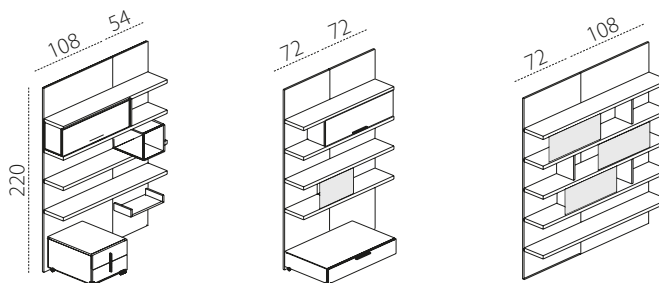
**PANNELLI BOISERIE**

Sp. 2,2 cm con piedini regolabili H 1,2 cm da terra. H pannello cm 218,8

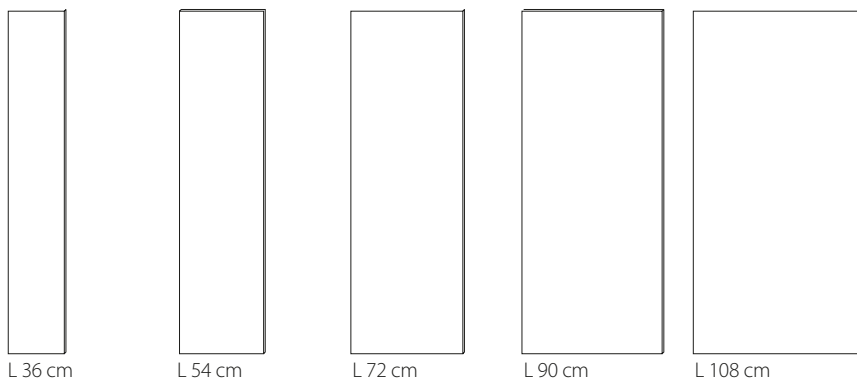

L 36 cm

L 54 cm

L 72 cm

L 90 cm

L 108 cm

FINITURE DI SERIE

Melaminico bianco, rovere sabbia, rovere moro, perla, tortora.
Laccato nelle varianti campionario Cleicoloursystem. Essenze: noce dogato, rovere termotrattato. Dialux bianco lucido.

MENSOLE BOISERIE

Sp. cm 4. P cm 28,7

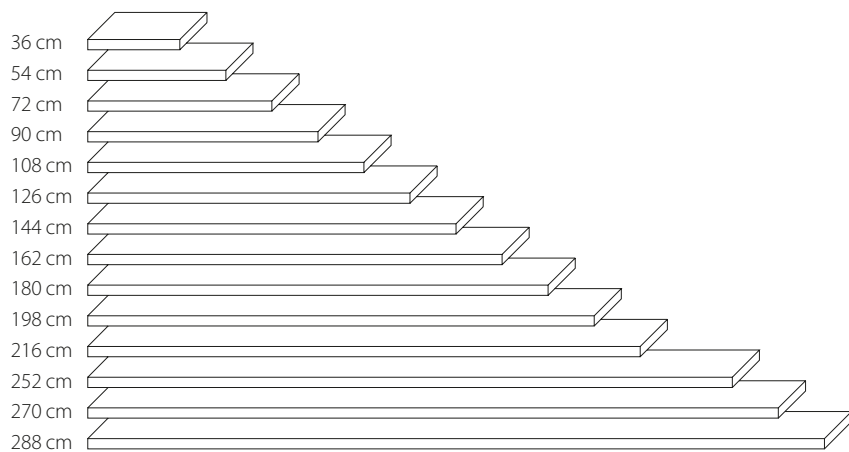

36 cm

54 cm

72 cm

90 cm

108 cm

126 cm

144 cm

162 cm

180 cm

198 cm

216 cm

252 cm

270 cm

288 cm

FINITURE DI SERIE

Melaminico bianco, rovere sabbia, rovere moro, perla, tortora.
Laccato nelle varianti campionario Cleicoloursystem. Essenze: noce dogato, rovere termotrattato.

MENSOLE BOISERIE CON SPALLETTE DI CONTENIMENTO

Spessore 2,2 cm - P 25cm - H spallette 8,7cm.

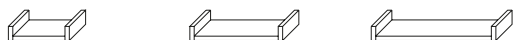

L 34,8 cm

L 52,8 cm

L 70,8 cm



L 88,8 cm

L 106,8 cm

FINITURE DI SERIE

Melaminico bianco, rovere sabbia, rovere moro, perla, tortora. Laccato nelle varianti campionario Cleicoloursystem.

ATTREZZATURA BOISERIEL 72 x P 27,6
H 32,1 cm

L 108 x P 27,6 H 32,1 cm

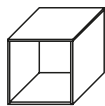

L 32,1 x P 35 H 32,1 cm

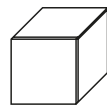

L 32,1 x P 37,2 H 32,1 cm



L 2,2 x P 25,3 H 32,1 cm

Elementi contenitore con anta ribalta da inserire tra due mensole con maniglia applicata o apertura a pressione.

Box in aggetto da inserire tra due mensole.

Box in aggetto con anta da inserire tra due mensole.

Fianco intermedio mensole boiserie. Da inserire solo se ci sono ante scorrevoli. A cm 54 dall'inizio della mensola.

ANTE SCORREVOLI INTERNE A 2 MENSOLE

Complete di binario di scorrimento della lunghezza desiderata. Sp. 2 cm.

L 54 x H 33,4 cm

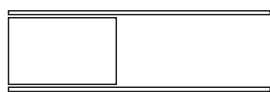

L 81 x H 33,4 cm

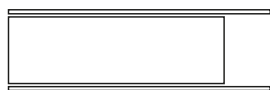

L 108 x H 33,4 cm

**ANTE SCORREVOLI ESTERNE A 2 MENSOLE**

Complete di binario di scorrimento della lunghezza desiderata.

L 72 x H 54 cm

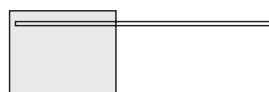

L 90 x H 54 cm



L 108 x H 54 cm

**FINITURE DI SERIE**

Melaminico bianco, rovere sabbia, rovere moro, perla, tortora. Laccato nelle varianti campionario Cleicoloursystem. Vetro laccato, vetro laccato riflettente.

FINITURE DI SERIE

Vetro laccato, vetro bianco riflettente, laccato lavagna scrivibile.

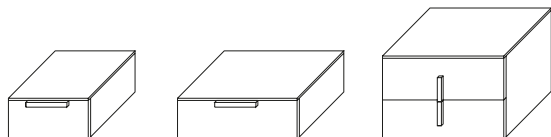
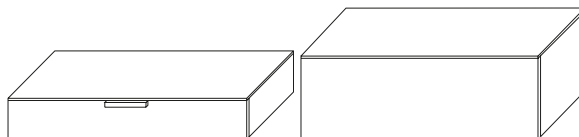
BASI CON CASSETTOL 36 x P 66,6
H 18,2 cmL 54 x P 66,6
H 18,2 cmL 54 x P 66,6
H 36,4 cm

L 108 x P 66,6 H 18,2 cm

L 108 x P 66,6 H 36,4 cm

FINITURE DI SERIE

Melaminico bianco, rovere sabbia, rovere moro, perla, tortora. Laccato nelle varianti campionario Cleicoloursystem.

FINITURE DI SERIE

Melaminico bianco, rovere sabbia, rovere moro, perla, tortora. Laccato nelle varianti campionario Cleicoloursystem. Essenze: noce dogato, rovere termotrattato.

SCRITTOI

Scrivani fissi, lineari e sagomati, completi di attrezzature con accessori per lo studio e per il pc. Integrabili con colonne e sistemi boiserie.

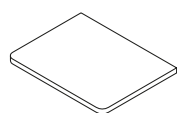
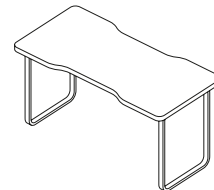
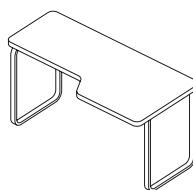
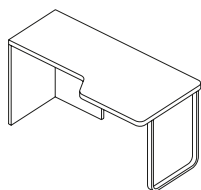

L 90 x P 70 cm

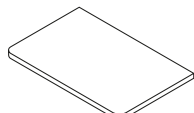

L 108 x P 70 cm

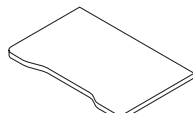

L 108 x P 70 cm

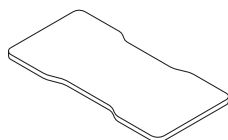

L 144 x P 70 cm

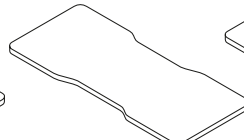

L 162 x P 70 cm

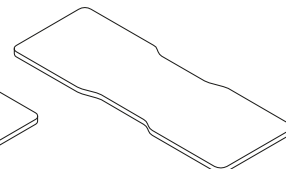

L 198 x P 70 cm

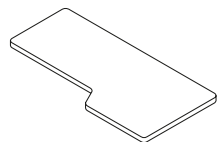
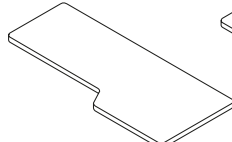
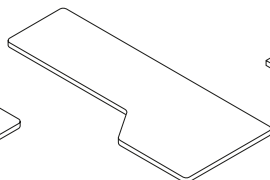
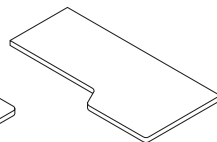
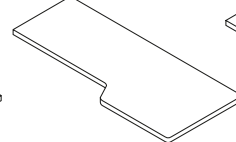
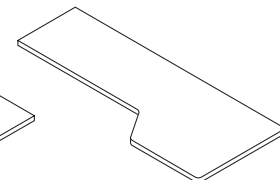
L 144 x P 54-70 cm
piano scrittoio con
angoli smussatiL 162 x P 54-70 cm
piano scrittoio con
angoli smussatiL 198 x P 54-82 cm
piano scrittoio con angoli
frontali smussatiL 144 x P 54-70 cm
piano scrittoio con
angoli frontali smussatiL 162 x P 54-70 cm
piano scrittoio con
angoli frontali smussatiL 198 x P 54-82 cm
piano scrittoio con angoli
frontali smussati

ACCESSORI

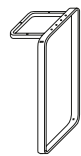
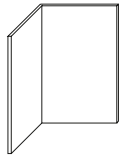
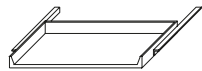
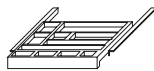
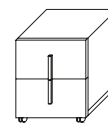
H 71,6 cm
Gamba in metalloL 35 x 54. H 71,6 cm
Fianco in legnoL 52 x P 24 cm
Porta-tastieraL 41,4 x P 50 cm
Porta-cancelleriaL 23 x P 47 cm
Porta-towerL 36 x P 45 H 41,6
cm
Cassettiera su ruote
a due cassettiL 36 x P 45 H 59,8
cm
Cassettiera su ruote
a tre cassetti

FINITURE DI SERIE

Melaminico bianco, rovere sabbia, rovere moro, perla, tortora. Laccato nelle varianti campionario Cleicoloursystem.

PENSILI

Elementi pensili verticali e orizzontali con schienali, ad uno e due vani, in versione giorno e con anta. Verticali con anta battente, orizzontali con anta a ribalta e vasistas. Gli schienali possono essere personalizzati con varianti colore differenti dalla struttura e con stampe.

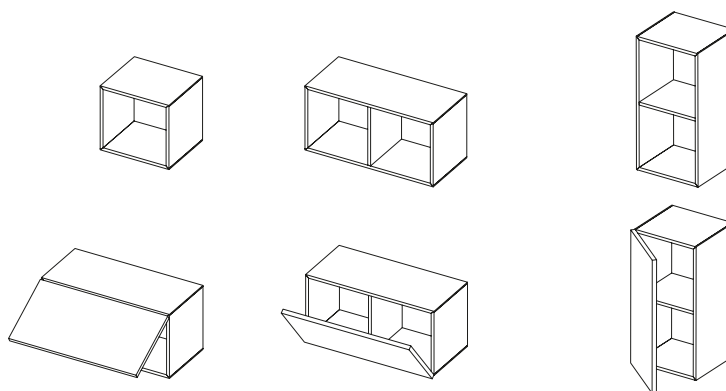
**FINITURE DI SERIE**

STRUTTURA - Melaminico bianco o laccato nelle varianti Cleicoloursystem.

SCHIENALE - Melaminico bianco, laccato nelle varianti Cleicoloursystem e stampa.

PENSILI QUADRATI A GIORNO

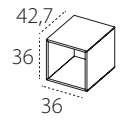
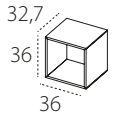

PENSILI VERTICALI E ORIZZONTALI A GIORNO

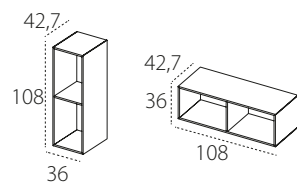
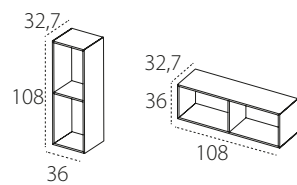
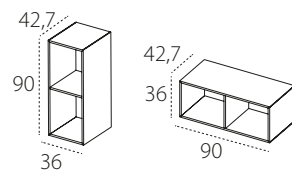
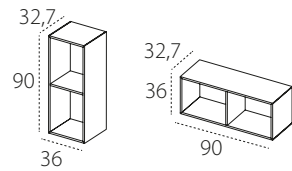
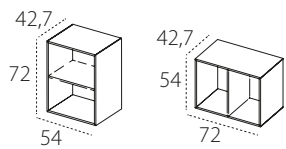
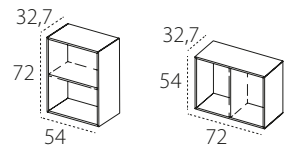
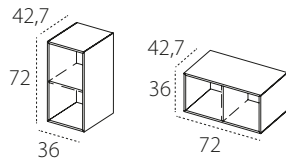
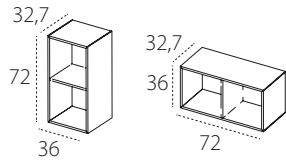

PENSILI VERTICALI CON ANTA BATTENTE

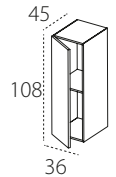
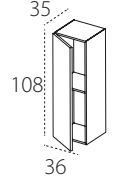
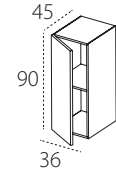
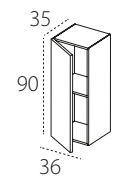
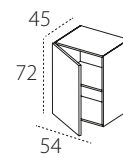
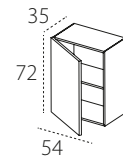
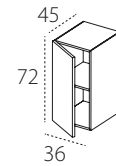
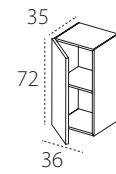

PENSILI ORIZZONTALI CON ANTA RIBALTA O VASISTAS

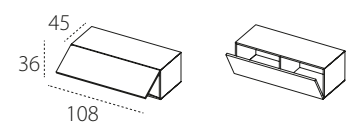
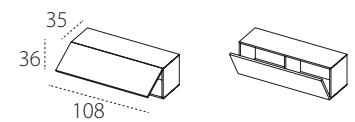
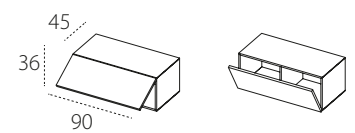
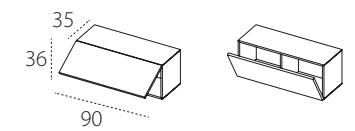
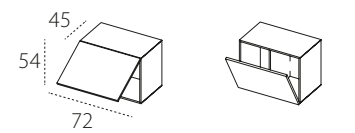
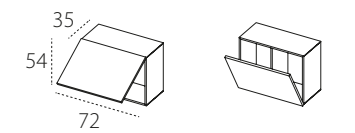
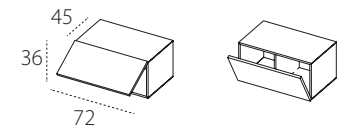
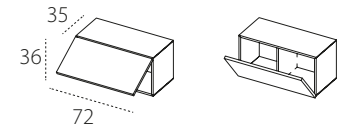

**ELEMENTI LATERALI KALI 90**

- Basi con 2 ripiani interni
- Top cm 40
- Top unico per elementi affiancati
- Piedini regolabili cm 12
- Apertura anta a pressione o con maniglia applicata
- Chiusura ammortizzata

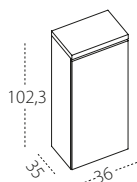

Elemento laterale 1 anta
L cm 36

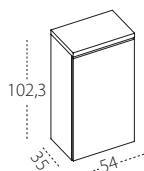

Elemento laterale 1 anta
L cm 54

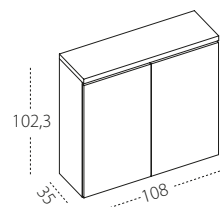

Elemento laterale 2 ante
L cm 108

ELEMENTI LATERALI KALI 120

- Basi con 2 ripiani interni
- Top cm 40
- Top unico per elementi affiancati
- Piedini regolabili cm 12
- Apertura anta a pressione o con maniglia applicata
- Chiusura ammortizzata

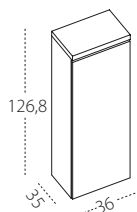

Elemento laterale 1 anta
L cm 36

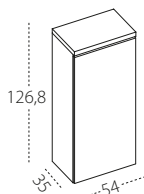

Elemento laterale 1 anta
L cm 54

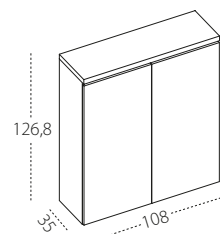

Elemento laterale 2 ante
L cm 108

PENSILI

- 2 ripiani interni
- Apertura anta a pressione
- Chiusura ammortizzata o con maniglia applicata

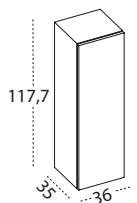

Pensile 1 anta L cm 36

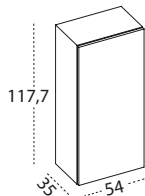

Pensile 1 anta L cm 54

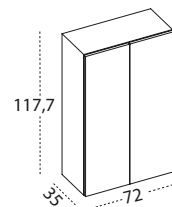

Pensile 2 ante L cm 72

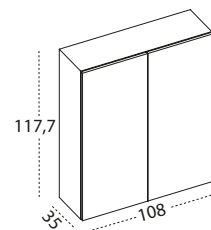

Pensile 2 ante L cm 108

TOP ELEMENTI BASE

Sp. cm 4. P cm 35

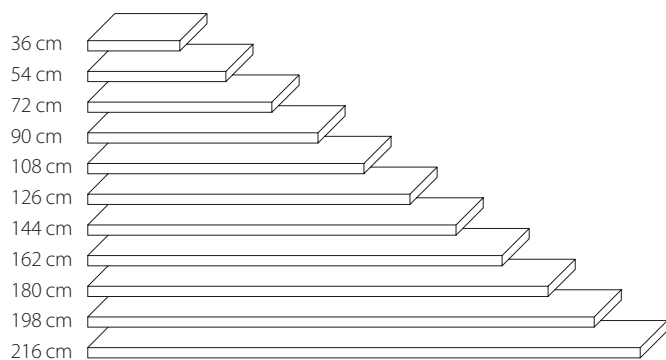
**FINITURE DI SERIE**

STRUTTURA E TOP - Melaminico bianco, rovere sabbia, rovere moro, perla, tortora. Laccato nelle varianti Cleicoloursystem.

ANTA - melaminico bianco, rovere sabbia, rovere moro, perla, tortora. Laccato nelle varianti Cleicoloursystem. Dialux bianco. Essenze: noce dogato e rovere termotrattato.



**BOISERIE CON MENSOLE
E PREDISPOSIZIONE PER
ELEMENTI BASI CON ANTA
RIBALTA**

Elementi L cm 36-54-72-108
Mensole P cm 28,7

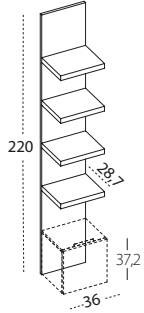

**BOISERIE CON MENSOLE A
TERRA**

Elementi L cm 36-54-72-108 con
N° 3 mensole P cm 28,7 e con N° 3
mensole P cm 32,7

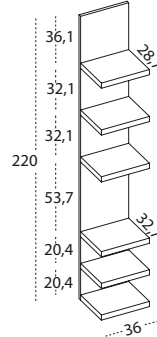

BOISERIE CON MENSOLE

Elementi L cm 36-54-72-108
Mensole P cm 32,7

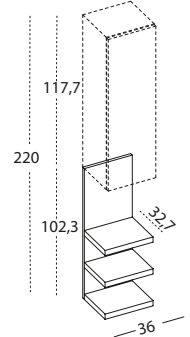

MENSOLE BOISERIE

Sp. cm 4

Le mensole vanno posizionate sui pannelli boiserie
esclusivamente dietro agli elementi del divano Tango

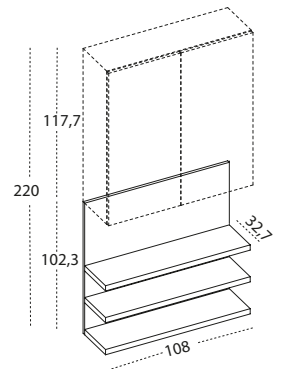
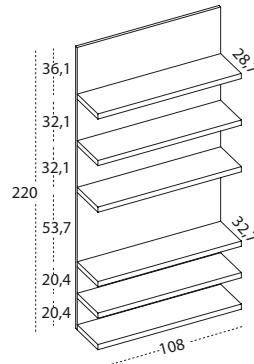
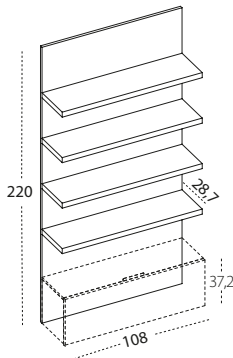
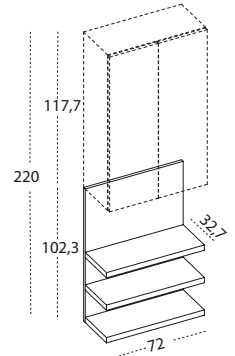
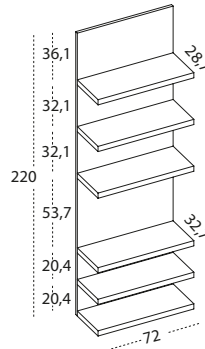
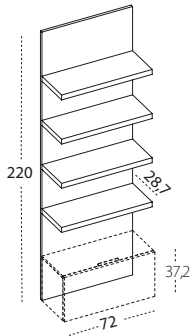
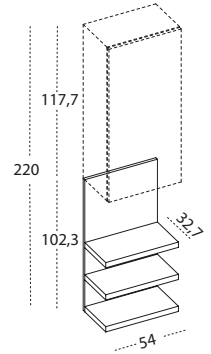
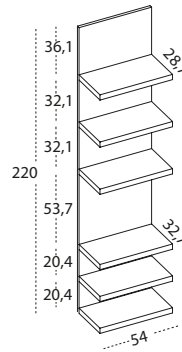
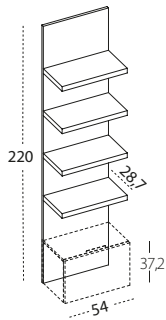
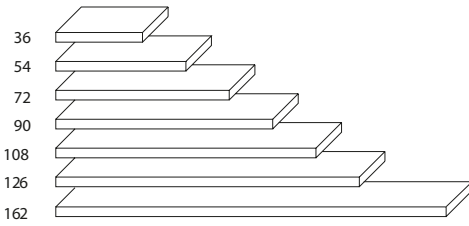

COLONNE SPECIALI

Colonne con anta battente e anta fissa per retro bracciolo sistema divano Tango/ Oslo/Penelope 2 e Circe (braccioli da 16 cm)

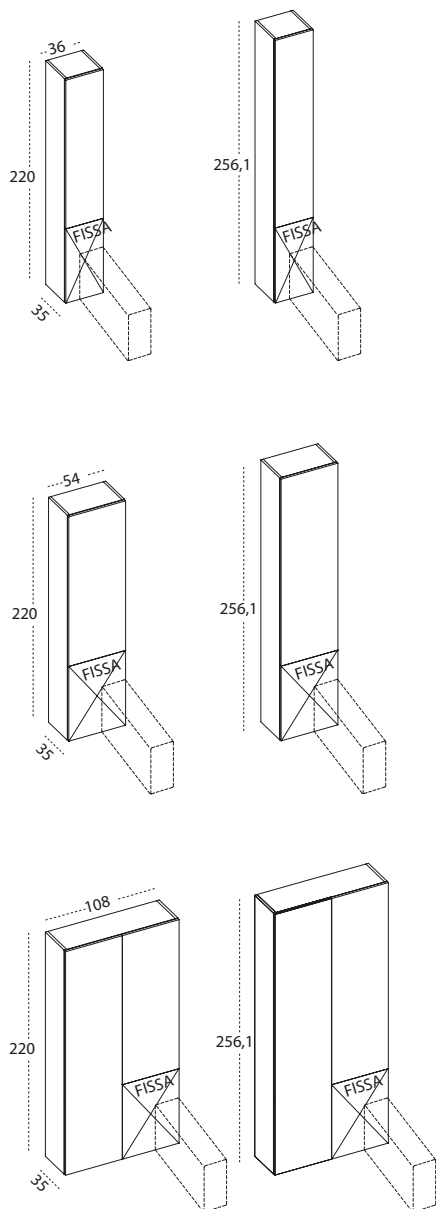
PENSILI

2 ripiani interni
Apertura anta a pressione
Chiusura ammortizzata

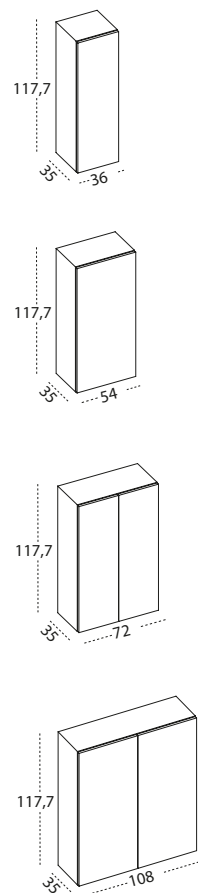
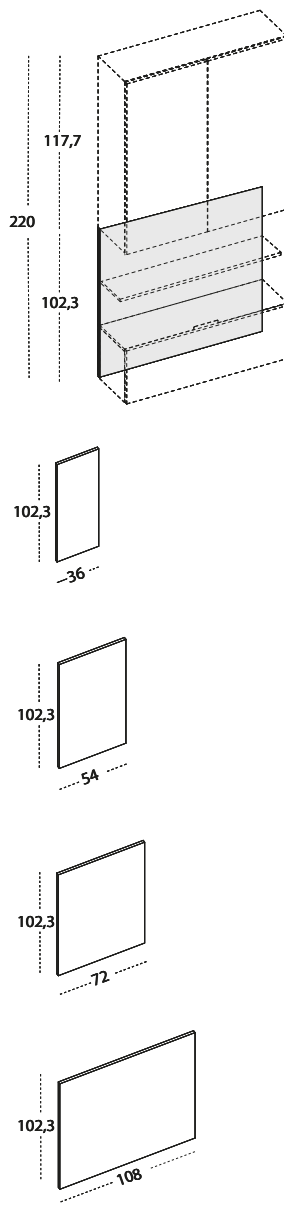
PANNELLO BOISERIEBASI CON ANTA RIBALTA

Per vano tra sistema letto e divano più libera installazione.

Specificare se la base è in appoggio a muro o boiserie.

Solo maniglia W016

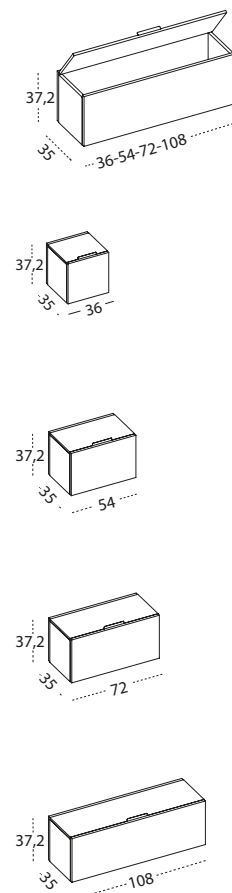
FINITURE DI SERIE

BASE CON ANTE A RIBALTA - Melaminico bianco, rovere sabbia, rovere moro, perla, tortora. Laccato nelle varianti Cleicoloursystem.

PANNELLO BOISEIRE - Melaminico bianco, rovere sabbia, rovere moro, perla, tortora. Laccato nelle varianti Cleicoloursystem. Dialux bianco. Essenze: noce dogato e rovere termotrattato.

MENSOLA BOISEIRE - Melaminico bianco, rovere sabbia, rovere moro, perla, tortora. Laccato nelle varianti Cleicoloursystem.

STRUTTURA COLONNA SPECIALE - Melaminico bianco, rovere sabbia, rovere moro, perla, tortora. Laccato nelle varianti Cleicoloursystem. Essenze: noce dogato e rovere termotrattato.

ANTA COLONNA SPECIALE - Melaminico bianco, rovere sabbia, rovere moro, perla, tortora. Laccato nelle varianti Cleicoloursystem. Dialux bianco. Essenze: noce dogato e rovere termotrattato.